

## General Description

The AAT3691 BatteryManager™ is an integrated single cell Lithium-Ion (Li-Ion) battery charger IC, designed to operate from USB ports, AC adapter inputs, or from a cellular phone charger adapter up to an input voltage of typical 6.75V. For increased safety, The AAT3691 also includes over-voltage input protection (OVP) up to 28V.

The AAT3691 precisely regulates battery charge voltage and current for 4.2V Li-Ion battery cells. The charge current can be programmed up to 1.6A for ADP charging and 0.5A for USB charging by external resistors on the ADPSET/USBSET pins. In the case of an over-voltage condition of ADP or USB input power exceeding typical 6.75V, the internal series switch opens, blocking the damage to the battery and charging circuitry.

The AAT3691 also includes a no-battery present input (NOBAT). When the NOBAT indicates that no battery is present, OVP block will prevent the input power from passing through the OVP block and suspend the charging function.

Battery charging status is continuously monitored for fault conditions. In the event of a battery over voltage or chip over thermal failure, the charger will automatically shutdown, protecting the charging device, control system and battery, until the fault condition is removed. The open drain status monitor output pin (STAT) is adopted to report battery charging activity by active low.

The AAT3691 comes in a thermally enhanced, space-saving, Pb-free 16-pin 3x4 mm TDFN package and is specified for operation over the -40°C to +85°C temperature range.

## Features

- Dual Input USB and AC Adapter Input
  - Programmable Constant Current from 100mA to 1.6A for ADP Charge
  - Programmable Constant Current from 50mA to 0.5A for USB Charge
- No Battery Present Input Detection
- 3.0V ~ 6.75V (typical) Input Voltage Range
- Over-Voltage Input Protection up to 28V
- High Level of Integration with Internal:
  - Power Device
  - Reverse Current Blocking
  - Current Sensing
- Automatic Recharge Sequencing
- Fast Over-Voltage Protection Turn Off and Release Turn On Time
- Full Battery Charge Auto Turn Off/Sleep Mode/Charge Termination
- Charge Status Indicator
- Automatic Trickle Charge for Battery Preconditioning
- Thermal Shutdown Protection
- Power On Reset and Soft Start
- Active Low Enable with Internal 200kΩ Resistor Pull-Down to GND
- 3x4mm TDFN Package

## Applications

- Digital Still Cameras
- Mobile Phones
- Personal Data Assistants (PDAs)
- Other Li-Ion Battery Powered Devices

## Typical Application

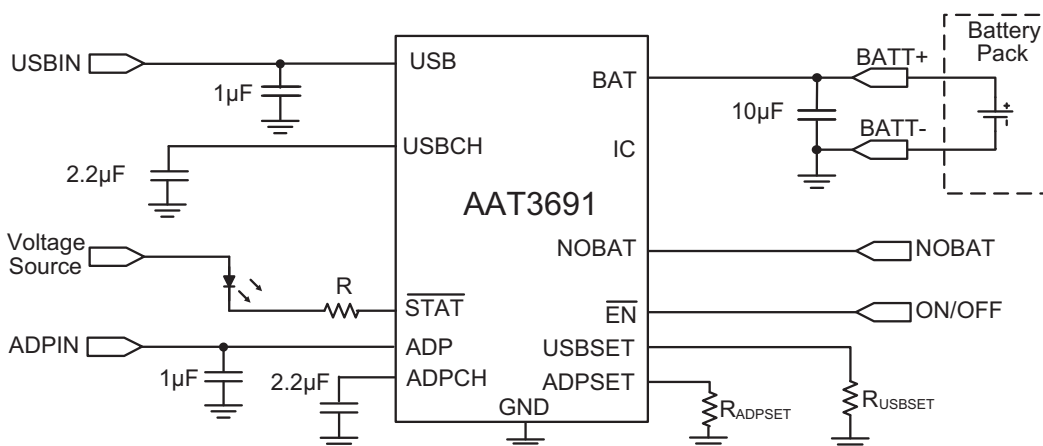

## Pin Descriptions

Pin #	Name	Type	Function
1	USB	I	Input from USB port connector
2	USBCH	I/O	Output from USB OVP stage, input to battery charger. Decouple with 2.2μF capacitor.
3	ADP	I	Input from adapter port connector
4	ADPCH	I/O	Output from ADP OVP stage, input to battery charger. Decouple with 2.2μF capacitor.
5, 7, 10	IC	I	Internally used. Connect to GND or leave floating.
6	STAT	O	Charge status indication pin, open drain.
8, 9	GND		Connect to power ground
11	EN	I	Active low enable with internal 200kΩ resistor pull-down to GND.
12	ADPSET	I	ADP charge current programming input pin.
13	USBSET	I	USB charge current programming input pin.
14	NOBAT	I	No battery present input. Logic "High" indicates no battery. Internal 1.6MΩ pull-high resistor.
15	N/C		No connection.
16	BAT	O	Connect to lithium-ion battery.

## Pin Configuration

**TDFN34-16  
(Top View)**

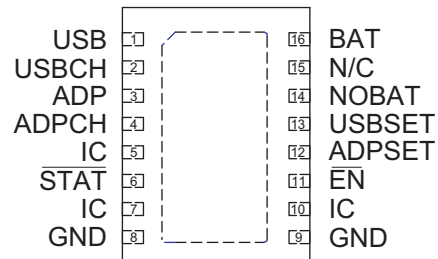



## Absolute Maximum Ratings<sup>1</sup>

Symbol	Description	Value	Units
$V_{ADP}, V_{USB}$	ADP, USB input continuous	28	V
$V_{ADPCH}, V_{USBCH}$	Charger input continuous	-0.3 to 7.5	V
$V_N$	BAT, $\overline{STAT}$ , $\overline{EN}$ , ADPSET, USBSET, NOBAT, IC	-0.3 to 7.5 + 0.3	V
$T_J$	Operating Junction Temperature Range	-40 to 150	°C
$T_{LEAD}$	Maximum Soldering Temperature (at Leads)	300	°C

## Thermal Information<sup>2</sup>

Symbol	Description	Value	Units
$\Theta_{JA}$	Maximum Thermal Resistance (TDFN 3x4)	50	°C/W
$P_D$	Maximum Power Dissipation	2	W

1. Stresses above those listed in Absolute Maximum Ratings may cause permanent damage to the device. Functional operation at conditions other than the operating conditions specified is not implied. Only one Absolute Maximum Rating should be applied at any one time.
2. Mounted on a FR4 board.

## Electrical Characteristics<sup>1</sup>

$V_{ADP} = V_{USB} = 5V$ ,  $T_A = -25^{\circ}C$  to  $+85^{\circ}C$ , unless otherwise noted. Typical values are at  $T_A = 25^{\circ}C$ .

Symbol	Description	Conditions	Min	Typ	Max	Units
<b>Operation</b>						
$V_{ADP\_MAX}$ , $V_{USB\_MAX}$	Input Over-Voltage Protection Range				28	V
$V_{ADP}$ , $V_{USB}$	ADP and USB Normal Operating Input Voltage Range		3.0		6.5	V
$I_{ADP\_OP}$ , $I_{USB\_OP}$	Operating Current	$V_{ADP}$ or $V_{USB} = 5V$ , Charge current = 100mA, $\overline{EN} = 0V$		0.5	1.5	mA
$I_{SD(OFF)}$	Shutdown Supply Current	$V_{ADP}$ or $V_{USB} = 5V$ , $\overline{EN} = 5V$		8		$\mu A$
$I_{STANDBY}$	Standby Mode Current	Charge Terminated		300		$\mu A$
$I_{BAT}$	Leakage Current from BAT Pin	$V_{BAT} = 4V$ , USB and ADP open		1	4	$\mu A$
<b>Over-Voltage Protection</b>						
$V_{OVPT}$	Over-Voltage Protection Trip Voltage	Rising edge	6.5	6.75	7.0	V
	Hysteresis			300		mV
<b>Battery Charger</b>						
$V_{UVLO\_ADP}$ , $V_{UVLO\_USB}$	Under-Voltage Lockout Threshold UVLO Hysteresis	Rising edge			3.0	V
				150		mV
<b>Voltage Regulation</b>						
$V_{BAT\_EOC}$	Output Charge Voltage Regulation		4.158	4.20	4.242	V
$\Delta V_{CH}/V_{CH}$	Output Charge Voltage Tolerance			0.5		%
$V_{MIN}$	Preconditioning Voltage Threshold		2.4	2.6	2.8	V
$V_{RCH}$	Battery Recharge Voltage Threshold			$V_{BAT\_EOC} - 0.1$		V
<b>Battery Charging Device</b>						
$R_{DS(ON)}$	Charging and OVP Total ON Resistance	$V_{ADP}$ or $V_{USB} = 5V$ , $T_A = 25^{\circ}C$			600	m $\Omega$
<b>Current Regulation</b>						
$I_{LIM\_ADP}$	ADP Charge Current Programmable Range		100		1600	mA
$I_{LIM\_USB}$	USB Charge Current Programmable Range		50		500	mA
$I_{CH\_CC}$	Constant-Current Mode Charge Current	$V_{BAT} = 3.6V$	-10		10	%
$V_{ADPSET}$ , $V_{USBSET}$	ADPSET, USBSET Pin Voltage			2		V
$KI_{ADPSET}$	Charge Current Set Factor: $I_{CH\_CC}/I_{ADPSET}$	Constant current mode, $V_{BAT} = 3.6V$		800		
$KI_{USBSET}$	Charge Current Set Factor: $I_{CH\_CC}/I_{USBSET}$	Constant current mode, $V_{BAT} = 3.6V$		800		
$I_{CH\_TRK}$	Trickle Charge Current	$R_{ADPSET} = 8k\Omega$	5	10	15	% $I_{CH\_CC}$
$I_{CH\_TERM}$	Charge Termination Threshold Current	$I_{CH\_CC} \geq 800mA$	8	10	12	%

1. The AAT3691 is guaranteed to meet performance specifications over the  $-40^{\circ}C$  to  $+85^{\circ}C$  operating temperature range and are assured by design, characterization and correlation with statistical process controls.

**Electrical Characteristics (continued)<sup>1</sup>**
 $V_{ADP} = V_{USB} = 5V$ ,  $T_A = -25^{\circ}C$  to  $+85^{\circ}C$ , unless otherwise noted. Typical values are at  $T_A = 25^{\circ}C$ .

Symbol	Description	Conditions	Min	Typ	Max	Units
<b>Logic Control / Battery Protection</b>						
$V_{EN\#(H)}$	Input High Threshold	$V_{ADP} = 5V$	1.2			V
$V_{EN\#(L)}$	Input Low Threshold				0.4	V
$V_{STAT}$	Output Low Voltage	STAT pin sinks 4mA			0.4	V
$I_{STAT}$	STAT Pin Current Sink Capability			4	8	mA
$V_{NOBAT(H)}$	No Battery Present Input High Threshold		1.2			V
$V_{NOBAT(L)}$	No Battery Present Input Low Threshold				0.4	V
$V_{BOVP}$	Battery Over-Voltage Protection Threshold			4.4		V
$T_{RESPOV}$	Over-Voltage Response Time	$V_{ADP}$ , $V_{USB}$ voltage step up signal from 6V to 8V		0.5	1.0	$\mu s$
$T_{OVPON}$	OVP Switch OVP Release Turn-On Delay Time	$V_{ADP}$ voltage step down signal from 8V to 6V, $R_{LOAD} = 10\Omega$ , $C_{ADPCH} = 1\mu F$		5		$\mu s$
$T_{OVSTARTON}$	OVP Switch Start Up Turn-On Delay Time	$V_{ADP}$ voltage step up signal from 0V to 5V, $R_{LOAD} = 10\Omega$ , $C_{ADPCH} = 1\mu F$		130		$\mu s$
$T_{OVPR}$	OVP Switch Turn-On Rise Time	$R_{LOAD} = 10\Omega$ , $C_{ADPCH} = 1\mu F$		100		$\mu s$
$T_{SHDN}$	Chip Thermal Shutdown Temperature	Thermal Shutdown Threshold		140		$^{\circ}C$
		Hysteresis		15		

1. The AAT3691 is guaranteed to meet performance specifications over the  $-40^{\circ}C$  to  $+85^{\circ}C$  operating temperature range and are assured by design, characterization and correlation with statistical process controls.

**Typical Characteristics**

**Over-Voltage Protection vs. Temperature**

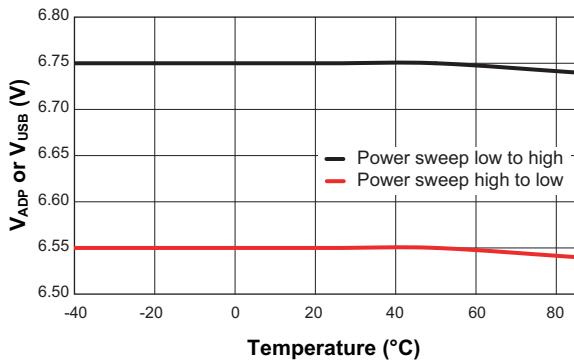

**End of Charge Voltage vs. Supply Voltage**  
( $R_{ADPSET} = 1k\Omega$ ,  $R_{USBSET} = 3.2k\Omega$ )

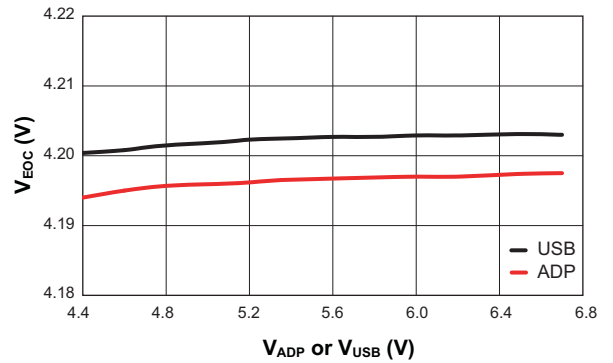

**I\_CHARGE vs. R\_ADPSET**

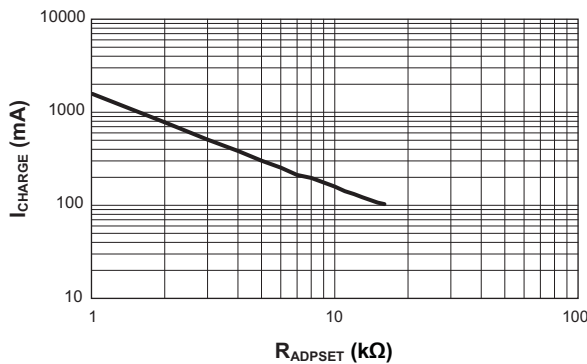

**I\_CHARGE vs. R\_USBSET**

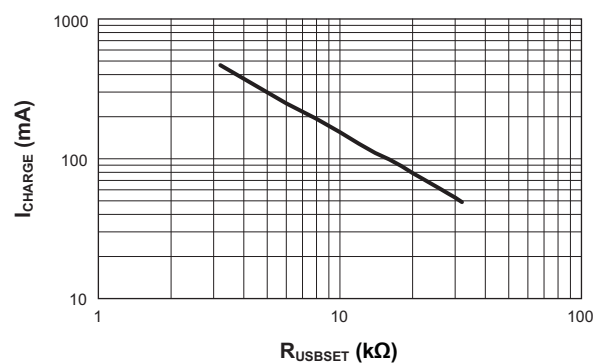

**Battery Recharge Voltage Threshold vs. Supply Voltage**  
( $R_{ADPSET} = 1k\Omega$ ;  $R_{USBSET} = 3.2k\Omega$ ;  $C_{BAT} = 22\mu F$ )

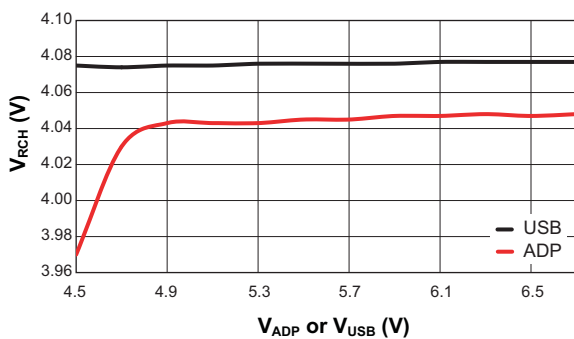

**Battery Recharge Voltage Threshold vs. Temperature**  
( $V_{ADP} = V_{USB} = 5V$ ;  $R_{ADPSET} = 1k\Omega$ ;  $R_{USBSET} = 3.2k\Omega$ ;  $C_{BAT} = 22\mu F$ )

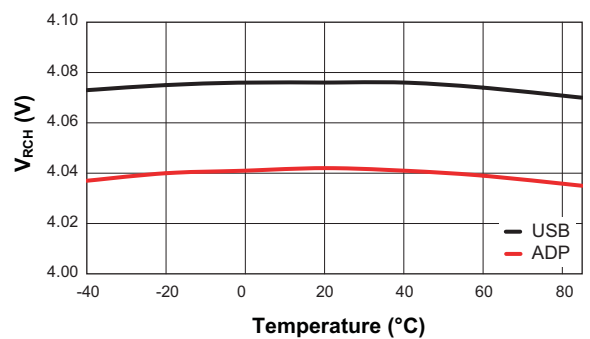

## Typical Characteristics

**End of Charge Voltage vs. Temperature**  
( $R_{ADPSET} = 1k\Omega$ ;  $R_{USBSET} = 3.2k\Omega$ )

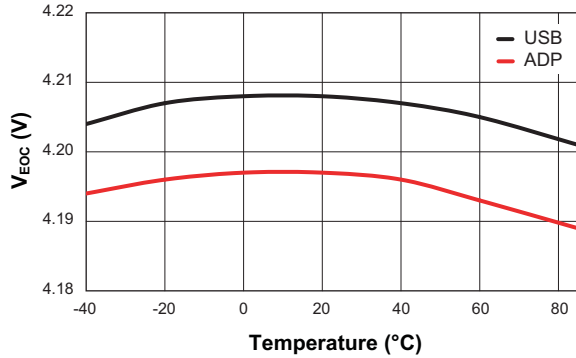

**Charge Current vs. Temperature**

( $V_{ADP} = V_{USB} = 5V$ ;  $V_{BAT} = 3.6V$ ;  
 $R_{ADPSET} = 1k\Omega$ ;  $R_{USBSET} = 3.2k\Omega$ )

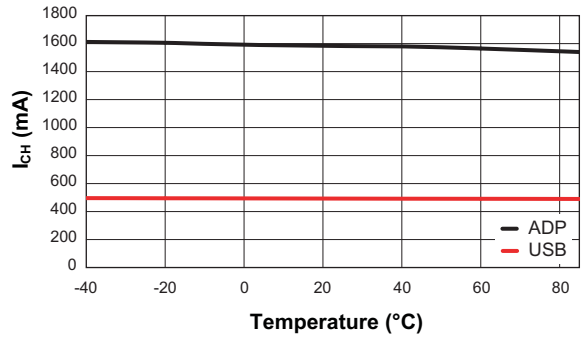

**Charging Current vs. Battery Voltage**  
( $V_{ADP} = V_{USB} = 5V$ ;  $R_{ADPSET} = 1k\Omega$ ;  $R_{USBSET} = 3.2k\Omega$ )

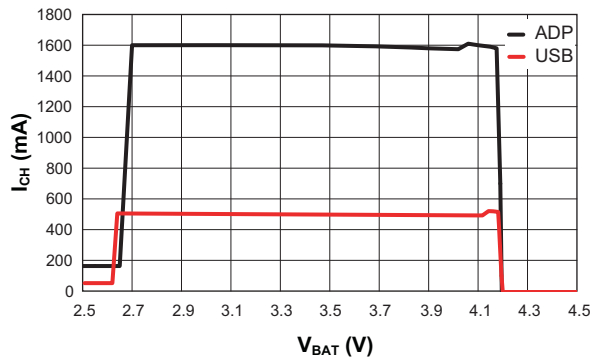

**USB Charging Current vs. Supply Voltage**  
( $R_{USBSET} = 3.2k\Omega$ )

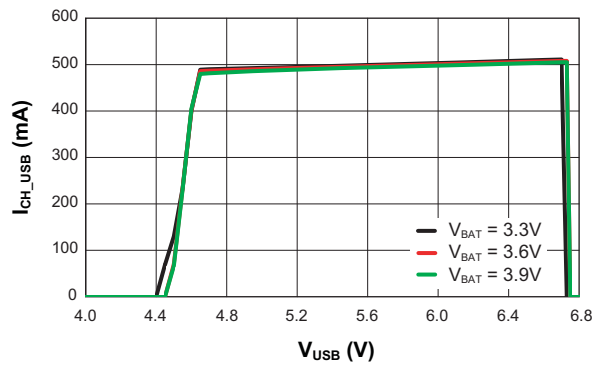

**ADP Charging Current vs. Supply Voltage**  
( $R_{ADPSET} = 1k\Omega$ )

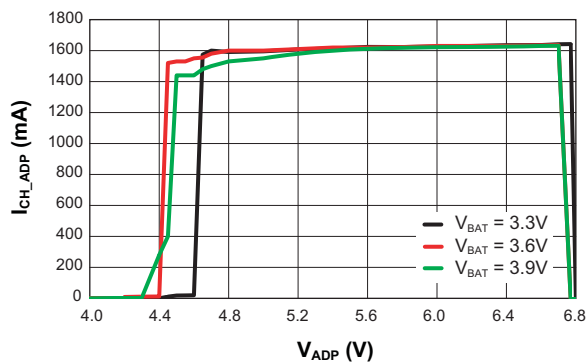

**USB Charging Current vs. Supply Voltage**  
( $R_{USBSET} = 3.2k\Omega$ )

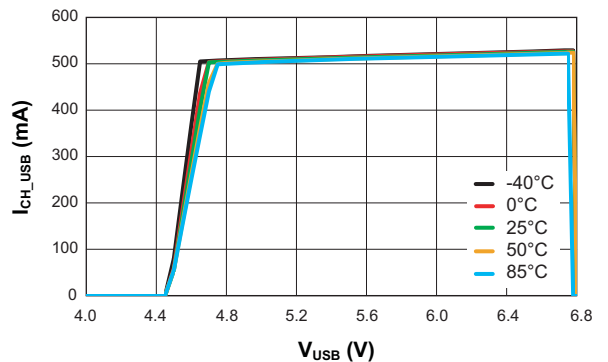

## Typical Characteristics

**ADP Charging Current vs. Battery Voltage**  
( $V_{ADP} = 5V$ )

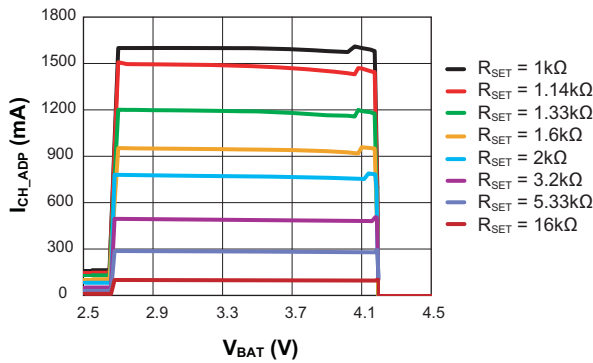

**USB Charging Current vs. Battery Voltage**  
( $V_{USB} = 5V$ )

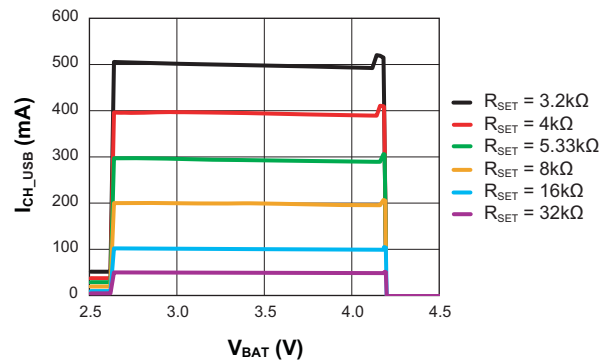

**NOBAT High Input Threshold vs. Input Power**

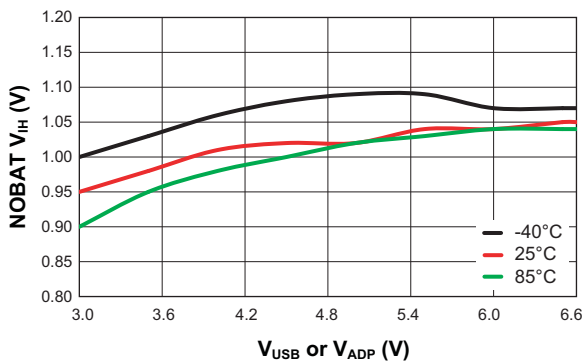

**NOBAT Low Input Threshold vs. Input Power**

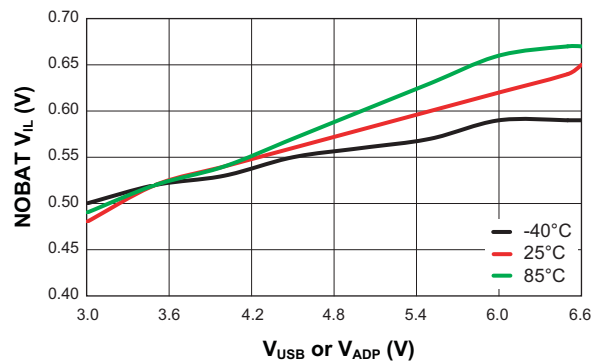

**Enable Input High Threshold vs. Input Power**

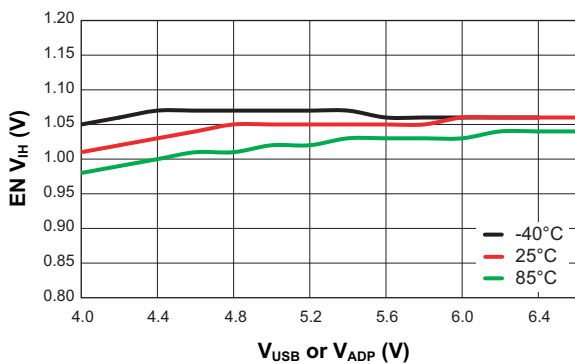

**Enable Input Low Threshold vs. Input Power**

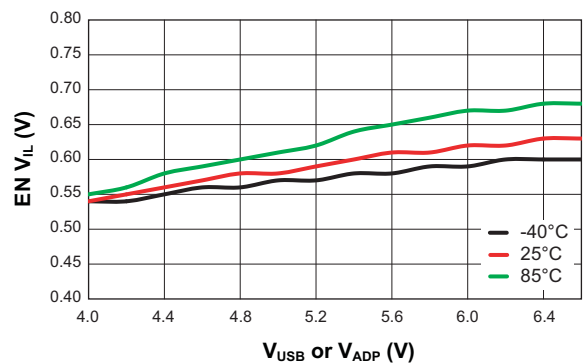



## Functional Block Diagram

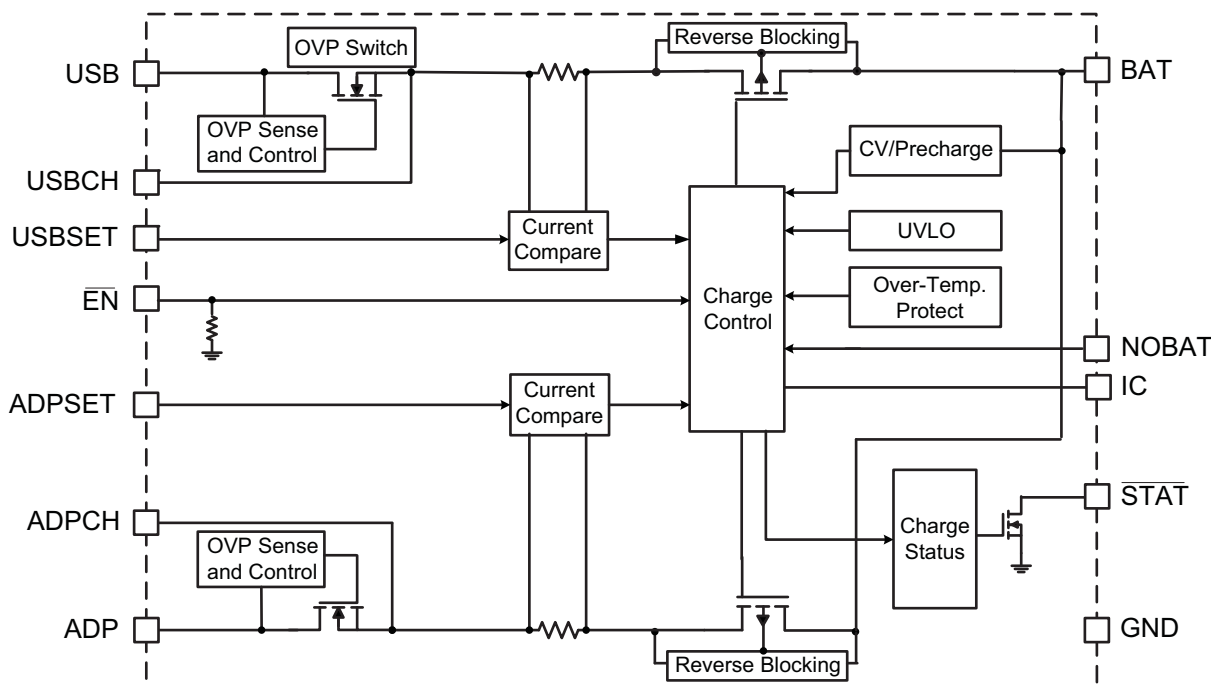

## Functional Description

The AAT3691 is a high performance battery charger designed to charge single cell Lithium Ion or Polymer batteries with up to 1600mA charging current from an adaptor (ADP) power source, or with up to 500mA charging current from an USB power source. The AAT3691 is a stand-alone charging solution, with just a few external component required for complete functionality. Both input paths include a fast turn-off over-voltage protection (OVP) circuit with voltage up to +28V and an under-voltage lockout level of 3.0V.

The AAT3691 automatically selects the charging source from USB or ADP according to ADP and USB voltage. The ADP path is always the high priority charging path when ADP voltage is higher than 4.5V. The charging current is determined by the selected charging path and its external set resistor ( $R_{SET}$ ).

USB charging uses an automatic charge reduction loop control allow battery charging with limited available current from a USB port while maintaining the regulated port voltage. This system assures that the battery charge function will not overload a USB port while charging if other system demands also share power with the respective port supply.

During adapter charging, high set charging current or high ambient operating temperature may cause the AAT3691 junction temperature to rise up to 110°C. A special digital thermal loop control system is employed to maximize charging current by dynamically decreasing the battery charging current.

Thermal protection shuts down the AAT3691's charging function when internal dissipation becomes excessive, while OVP function still works. The junction over-temperature threshold is 140°C with 15°C of hysteresis. Once an over-temperature condition is removed, the charging function automatically recovers.

The status monitor output pin ( $\overline{STAT}$ ) is designed to indicate the battery charge status with open-drain structure by directly driving one external LED.

## Battery Charging Operation

Regardless of which charge input function is selected (adapter input or USB input), the AAT3691 has three basic modes for the battery charge cycle: preconditioning (trickle) charge, constant current/fast charge, and constant voltage charge. When no automatic charge reduction mode or digital thermal loop is triggered, the charge profile is controlled as shown in Figure 1.

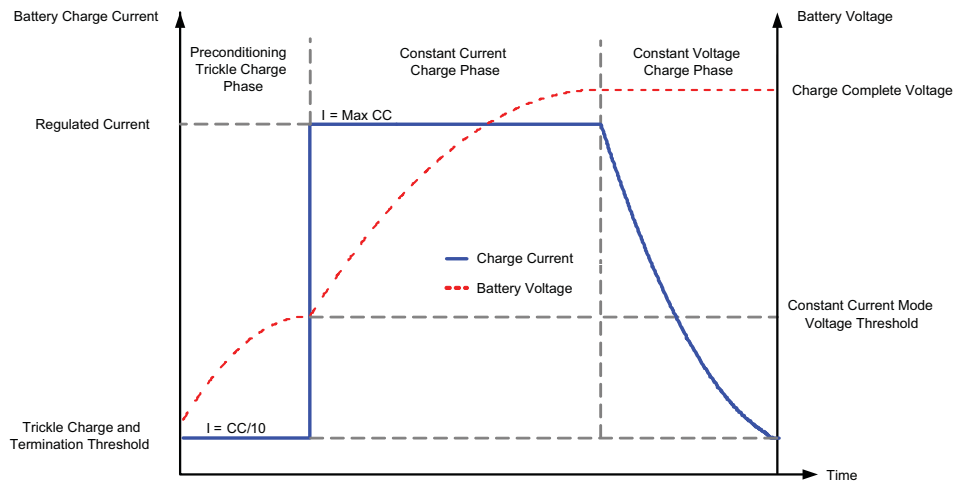

**Figure 1: Charge Current vs. Battery Voltage Profile during Charging Phases.**

Battery charging commences only after the AAT3691 checks several conditions in order to maintain a safe charging environment. The input supply must be above the minimum operating voltage and the enable pin must be low. When the battery is connected to the BAT pin and the NOBAT pin indicates there is a battery connected, the AAT3691 checks the condition of the battery and determines which charging mode to apply. If the battery voltage is below  $V_{MIN}$ , then the device begins trickle charging by charging at 10% of the programmed constant current. For example, if the programmed current is 500mA, then the trickle charge current is 50mA. Trickle charging is a safety precaution for a deeply discharged cell and will also reduce the power dissipation in the internal series pass MOSFET when the input-output voltage differential is at its highest. Trickle charging continues until the battery voltage reaches  $V_{MIN}$ . At this point, the AAT3691 begins constant current charging. The current value for this mode is programmed by the external resistors from the ADPSET and USBSET pin to ground. Programmed current can be set from a minimum of 100mA up to a maximum of 1.6A for an ADP power source, and from a minimum of 50mA up to a maximum of 500mA for a USB power source. Constant current charging continues until the battery voltage reaches the voltage regulation point,  $V_{BAT\_EOC}$ . When the battery voltage reaches  $V_{BAT\_EOC}$  (typical 4.2V), the AAT3691 will switch to constant voltage mode. Constant current charge will continue until the charging current is reduced to 10% of the programmed current. After the charge

cycle is complete, the AAT3691 turns off the series pass device and automatically goes into standby mode. During this time, the series pass device will block current in both directions, therefore preventing the battery from discharging through the IC.

The AAT3691 remains in standby mode until either the battery terminal voltage drops below the  $V_{RCH}$  threshold, the charger  $\overline{EN}$  pin is recycled, or the charging source is reconnected. In all cases, the AAT3691 will monitor all parameters and resume charging in the most appropriate mode.

### Over-Voltage Protection

In normal operation an OVP switch acts as a slew-rate controlled load switch, connecting and disconnecting the power supply from ADP to ADPCH and USB to USBCH. A low-resistance MOSFET is used to minimize the voltage drop between the voltage source and the charger and to reduce the power dissipation. When the voltage on the input exceeds the 6.75V (typical) voltage limit, the device immediately turns off the internal OVP switch, disconnecting the load from the abnormal voltage and preventing damage to any downstream components.

On initial power-up with low and battery present, if  $V_{USB/ADP} < V_{UVLO}$  (3V maximum), the OVP switch is held off; if  $V_{UVLO} < V_{USB/ADP} < 6.75V$  (typical), the OVP switch will turn on after a 130 $\mu$ s typical internal delay; if  $V_{USB/ADP}$  rises above 6.75V (typical), the OVP switch is turned off after a 0.5 $\mu$ s typical internal delay.

**System Operation Flowchart**

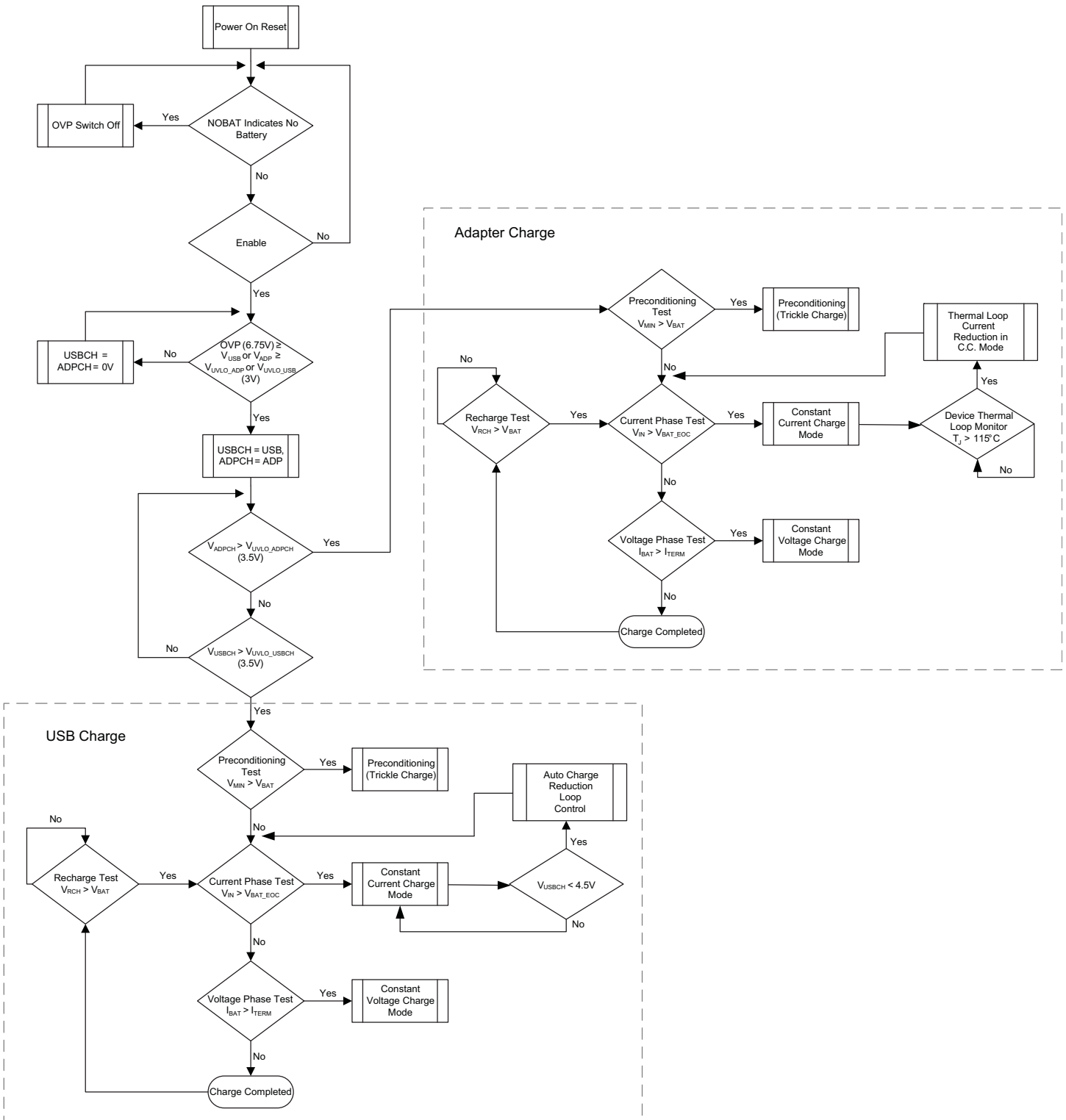

## Application Information

### Charge Sources

The AAT3691 operates from sources of an adapter or USB interface. The internal system control will always select the adapter input to charge the battery rather than the USB input if the adapter voltage is above 4.5V. The normal charging input voltage range is up to typical 6.75V. The device can withstand up to 28V on the adapter or USB inputs without damage to the IC. If  $V_{ADP}$  or  $V_{USB}$  is greater than 6.75V, the internal over-voltage protection circuitry disables charging until the input falls below typical 6.55V.

### AC Adapter/USB System Power Charging

#### Adapter Mode

In the adapter mode, constant current charge levels up to 1.6A can be programmed by the user. The fast charge current for the adapter input mode is set by the  $R_{ADPSET}$  resistor connected between ADPSET and ground. It is programmed by the following equations:

$$I_{ADP\_CC} = \frac{2}{R_{ADPSET}} \cdot KI_{ADPSET}$$

$$R_{ADPSET} = \frac{2}{I_{ADP\_CC}} \cdot KI_{ADPSET}$$

with  $KI_{ADPSET} = 800$ . Table 1 gives the recommended 1% tolerance metal film resistance values for a desired constant current charge level.

#### Thermal Loop Control

To protect the linear charging IC from thermal problems, a special thermal loop control system is used to maximize charging current under adapter charge mode. The thermal management system measures the internal circuit die temperature and reduces the fast charge current when the die exceeds the preset internal temperature control threshold. Once the thermal loop control becomes active, the fast charge current is initially reduced by a factor of 0.44.

The initial thermal loop current can be estimated by the following equation:

$$I_{TLOOP} = I_{CC} \cdot 0.44$$

$I_{CH\_CC}$ (mA)	$R_{ADPSET}$ (k $\Omega$ )	$R_{USBSET}$ (k $\Omega$ )
50		32.4
75		21.5
100	16	16
200	8.06	8.06
300	5.36	5.36
400	4.02	4.02
500	3.24	3.24
600	2.67	
700	2.32	
800	2	
900	1.78	
1000	1.60	
1100	1.47	
1200	1.33	
1300	1.24	
1400	1.15	
1500	1.07	
1600	1	

**Table 1: Standard 1% Metal Film Resistor Values for Constant Current Setting.**

The thermal loop control re-evaluates the circuit die temperature every three seconds and raises the fast charge current in small steps to the full fast charge current level. Figure 2 illustrates the thermal loop function at 1A fast charge current as the ambient temperature increases and recovers. In this manner the thermal loop controls the system charge level, and the AAT3691 provides the highest level of constant current in the fast charge mode for any possible valid ambient temperature condition.

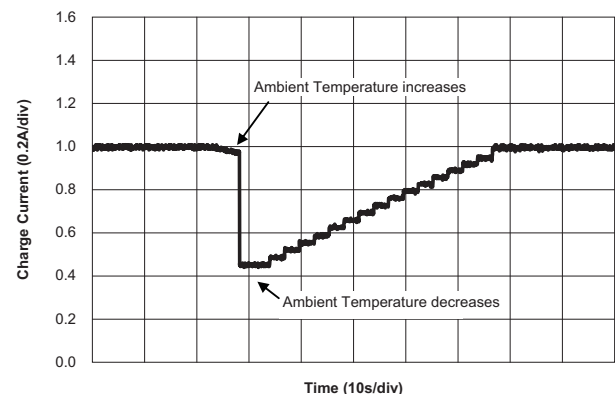

**Figure 2: Digital Thermal Loop Function at 1A Fast Charge Current with Ambient Temperature Increasing and Recovering.**

### Adapter Input Charge Inhibit and Resume

The AAT3691 has an under-voltage lockout feature so that if the charger input supply ADP pin drops below the UVLO threshold, the charger will suspend charging. When the UVLO condition is removed and  $V_{ADPCH} > V_{BATr}$ , the system charge control assesses the state of charge of the battery cell and automatically resumes charging in the appropriate phase (pre-conditioning trickle charge, constant current charge, constant voltage charge or end of charge) according to the condition of the battery.

### USB Mode

The AAT3691 also provides an input for intelligent USB charging. When no voltage is present on the adapter input pin or adapter input is below 4.5V, the charge controller will automatically switch to accepting power from the USB input. The USB charge may be user programmed to any level between 50mA and 500mA by selecting the appropriate resistor values for  $R_{USBSET}$ .

$$I_{USB\_CC} = \frac{2}{R_{USBSET}} \cdot KI_{USBSET}$$

$$R_{USBSET} = \frac{2}{I_{USB\_CC}} \cdot KI_{USBSET}$$

Among them,  $KI_{USBSET}$  is 800. Refer to Table 1 for recommended  $R_{USBSET}$  values for the desired USB input constant current charge levels.

### USB Charge Reduction

In many instances, product system designers do not know the real properties of a potential USB port used to supply power to the battery charger. Typically, powered USB ports found on desktop and notebook PCs should supply up to 500mA. If a USB port being used to supply the charger is unable to provide the programmed fast charge current or if the system under charge must share supply current with other functions, the AAT3691 automatically reduces USB fast charge current to maintain port integrity and protect the host system.

The USB charge reduction system becomes active when the voltage on the USBCH input falls below the USB charge reduction threshold, typically 4.5V. The charge reduction system reduces the fast charge current level in a linear fashion until the voltage sensed on the USB input recovers above the charge reduction threshold voltage.

### USB Input Charge Inhibit and Resume

The AAT3691 UVLO and power on reset feature functions when the USB input pin voltage level drops below the UVLO threshold. At this point, the charger suspends charging and shuts down. When power is re-applied to the USB pin or the UVLO condition recovers, the system charge control will assess the state of charge on the battery cell and automatically resume charging in the appropriate mode for the condition of the battery.

### Enable / Disable

The AAT3691 provides an enable function to allow the normal operating input voltage to pass through and control the IC charging. The Enable ( $\overline{EN}$ ) pin is active low and is pulled down to ground by an internal 200kΩ resistor. When pulled to a logic high level, the AAT3691 is shut down and forced into the sleep state during which input voltage up to 28V will be blocked and charging be halted regardless of the battery voltage or charging state. When the device is re-enabled, the OVP block will automatically reassess the input voltage and allow the normal operating voltage to pass through. If a battery is also present (NOBAT is low), the charge control circuit will automatically reset and resume charging with the appropriate charging mode based on the battery charge state and measured cell voltage.

### Over-Temperature Shutdown

Thermal protection completely disables charging when internal dissipation exceeds the junction over-temperature threshold, which is 140°C with 15°C of hysteresis. Once the over-temperature fault condition is removed, the charge function automatically recovers.

### Battery Charge Status Indication

The AAT3691 has one status LED driver output. The LED can indicate simple functions such as battery charging, charge complete, and charge disabled.

Description	EN	LED Status
Battery charging	low	on
Charge complete	low	off
Charge disabled	high	off

**Table 2. LED Status Conditions.**

The LED anodes should be connected to either  $V_{USBCH}$  or  $V_{ADPCH}$ , depending upon the system design requirements. The LEDs should be biased with as little current as necessary to create reasonable illumination; therefore, a ballast resistor should be adopted to limit the current flowing through the LED by connecting it with the LED in series between  $\overline{STAT}$  and  $V_{USBCH}$  or  $V_{ADPCH}$ . LED current consumption will add to the overall thermal power budget for the device package, so LED drive current should be kept to a minimum. 2mA should be sufficient to drive most low-cost green or red LEDs. It is not recommended to exceed 8mA for driving an individual status LED. The required ballast resistor value can be estimated using the following formulas:

To connect to ADPCH:

$$R = \frac{V_{ADPCH} - V_{FLED}}{I_{LED}}$$

To connect to USBCH:

$$R = \frac{V_{USBCH} - V_{FLED}}{I_{LED}}$$

For example, using a red LED with 2.0V  $V_F$  @ 2mA, calculate R under 5.5V  $V_{ADPCH}$ :

$$R = \frac{5.5V - 2.0V}{2mA} = 1.75k\Omega$$

## Capacitor Selection

### Input Capacitor

An input capacitor is used to filter the input voltage by placing a decoupling capacitor between the ADP, ADPCH, USB and USBCH pins and ground. An input capacitor in the range of 1 $\mu$ F to 10 $\mu$ F is recommended. If the source supply is unregulated, it may be necessary to increase the capacitance to keep the input voltage above the under-voltage lockout threshold during device enable and when battery charging is initiated. This input capacitor range is also suitable for a system with an external power supply source, such as a typical AC-to-DC wall adapter. It will minimize switching or power bounce effects when the power supply is "hot plugged". Likewise, a 2.2 $\mu$ F or greater input capacitor is recommended for the USB input to help buffer the effects of USB source power switching, noise, and input cable impedance.

### Output Capacitor

The AAT3691 requires a 1 $\mu$ F ceramic capacitor on the BAT pin to maintain circuit stability. This value should be increased to 10 $\mu$ F or more if the battery connection is made any distance from the charger output. In a fast charge application with current above 1A, a 22 $\mu$ F output capacitor is required to obtain an accurate recharge voltage threshold. If the AAT3691 is used in applications where the battery can be removed from the charger, such as in the case of desktop charging cradles, an output capacitor value greater than 10 $\mu$ F may be required to prevent the device from cycling on and off when no battery is present.

### Thermal Considerations

The actual maximum charging current is a function of the charge input voltage (USBCH and ADPCH), the battery voltage at the BAT pin, the ambient temperature, the rising temperature when charge current passing through the  $R_{DS(ON)}$  of the charging pass, and the thermal impedance of the package. The maximum programmable current may not be achievable under all operating parameters.

The AAT3691 is offered in a 3x4mm TDFN package which can provide up to 2.0W of power dissipation when properly soldered to a printed circuit board and has a maximum thermal resistance of 50°C/W. Many considerations should be taken into account when designing the printed circuit board layout, as well as the placement of the charger IC package in proximity to other heat generating devices in a given application design. The ambient temperature around the charger IC will also have an effect on the thermal limits of a battery charging application. The maximum limits that can be expected for a given ambient condition can be estimated by the following discussion:

First, the maximum power dissipation for a given situation should be calculated:

$$P_D = [(V_{IN} - V_{BAT}) \cdot I_{CC} + (V_{IN} \cdot I_{OP})]$$

Where:

$P_D$  = Total power dissipation of the AAT3691

$V_{IN}$  =  $V_{ADP}$  or  $V_{USB}$ , depending on which mode is selected

$V_{BAT}$  = Battery voltage at the BAT pin

$I_{CC}$  = Maximum constant fast charge current programmed for the application

$I_{OP}$  = Quiescent current consumed by the charger IC for normal operation.



Next, the maximum operating ambient temperature for a given application can be estimated based on the thermal resistance of the 3x4 TDFN package when sufficiently mounted to a PCB layout and the internal thermal loop temperature threshold.

$$T_A = T_J - (\theta_{JA} \cdot P_D)$$

Where:

$T_A$  = Ambient temperature in °C

$T_J$  = Maximum device junction temperature below the thermal loop threshold

$P_D$  = Total power dissipation by the device

$\theta_{JA}$  = Package thermal resistance in °C/W.

Example:

For an application where the fast charge current for the adapter mode is set to 1A,  $V_{ADP} = 5.0V$ , and the worst case battery voltage is 3.6V, what is the maximum ambient temperature at which the digital thermal loop limiting will become active?

Given:

$$V_{ADP} = 5.0V$$

$$V_{BAT} = 3.6V$$

$$I_{CC} = 1A$$

$$I_{OP} = 0.25mA$$

$$T_J = 110^\circ C$$

$$\theta_{JA} = 50^\circ C/W$$

The device power dissipation for the stated condition can be calculated as below:

$$P_D = (5.0 - 3.6V) \cdot 1A + (5.0V \cdot 0.25mA) \approx 1.4W$$

The maximum ambient temperature is

$$T_A = 110^\circ C - (50^\circ C/W \cdot 1.4W) = 40^\circ C$$

Therefore, under the stated conditions for this worst case power dissipation example, the AAT3691 will enter the digital thermal loop and lower the fast charge constant current when the ambient operating temperature rises above 40°C.

### **Printed Circuit Board Layout Considerations**

For the best results, it is recommended to physically place the battery pack as close to the AAT3691 BAT pin as possible. To minimize voltage drops on the PCB, keep the high current carrying traces adequately wide. For maximum power dissipation of the AAT3691 TDFN package, the exposed pad should be soldered to the board ground plane to further increase local heat dissipation. A ground pad below the exposed pad is strongly recommended.

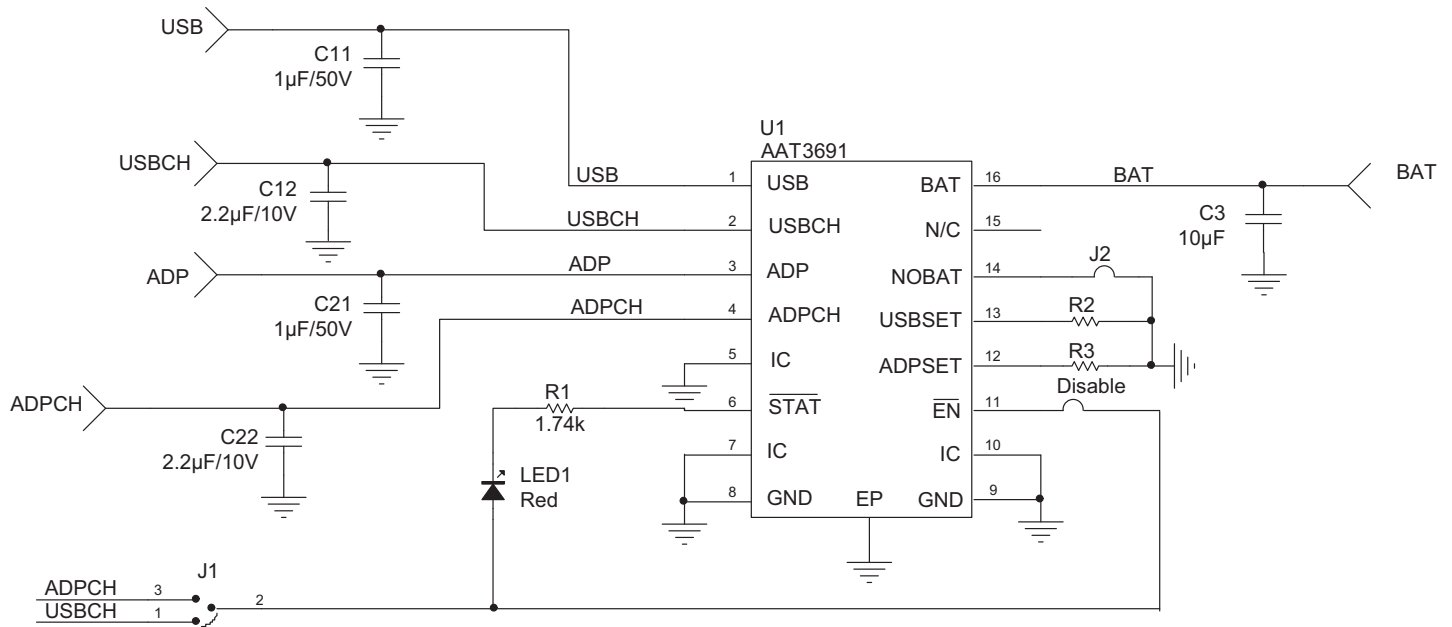

Figure 3: AAT3691 Evaluation Board Schematic.

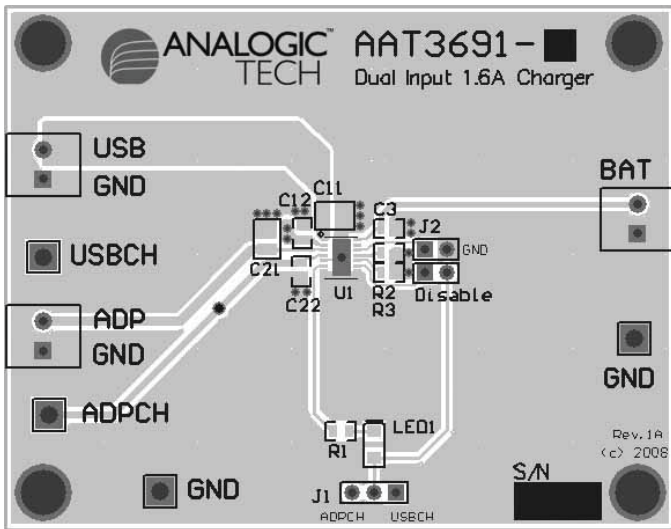

Figure 4: AAT3691 Evaluation Board Top Side Layout.

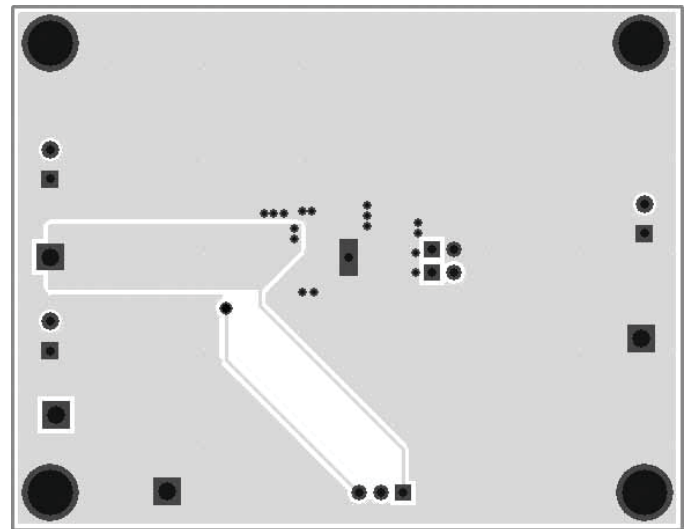

Figure 5: AAT3691 Evaluation Board Bottom Side Layout.



Component	Part Number	Description	Manufacturer
U1	AAT3691IRN-T1	0.5A USB Port /1.6A Adapter Lithium-Ion; 16-Pin 3x4 TDFN Package	AnalogicTech
R1	RC0603FR-071K74L	Res 1.74KΩ 1/10W 1% 0603 SMD	Yageo
R2	RC0603FR-073K24L	Res 3.24KΩ 1/10W 1% 0603 SMD	Yageo
R3	RC0603FR-072KL	Res 1.6KΩ 1/10W 1% 0603 SMD	Yageo
C3	GRM188R60J106M	Cap Ceramic 10μF 0603 X5R 6.3V 20%	Murata
C11, C21	GRM21BR71H105K	Cap Ceramic 1μF 0805 X7R 50V 10%	Murata
C12, C22	GRM188R61A225K	Cap Ceramic 2.2μF 0603 X5R 10V 10%	Murata
J1	TMM-103-03-T-S	Conn. 3-pin header, 2.54mm Pitch	Samtec
J2, Disable	TMM-102-03-T-S	Conn. 2-pin header, 2.54mm Pitch	Samtec
LED1	0805KRCT	Red LED; 0805	HB
ADP, USB, BAT	DG308-2.54-02-14	Multi-position micro PCB terminal blocks, 2.54mm, 2 pin, Green	Degson
ADPCH, USBCH	5010K-ND	Red Test point	Keystone
G1, G2	5011K-ND	Black Test point	Keystone

**Table 3: AAT3691 Evaluation Board Bill of Materials.**

### Ordering Information

Package	NOBAT Input	EOC Voltage	Marking <sup>1</sup>	Part Number (Tape and Reel) <sup>2</sup>
TDFN34-16	Active high	4.2	4TXY	<b>AAT3691IRN-4.2-T1</b>



All AnalogicTech products are offered in Pb-free packaging. The term “Pb-free” means semiconductor products that are in compliance with current RoHS standards, including the requirement that lead not exceed 0.1% by weight in homogeneous materials. For more information, please visit our website at <http://www.analogictech.com/about/quality.aspx>.

### Package Information

TDFN34-16<sup>3</sup>

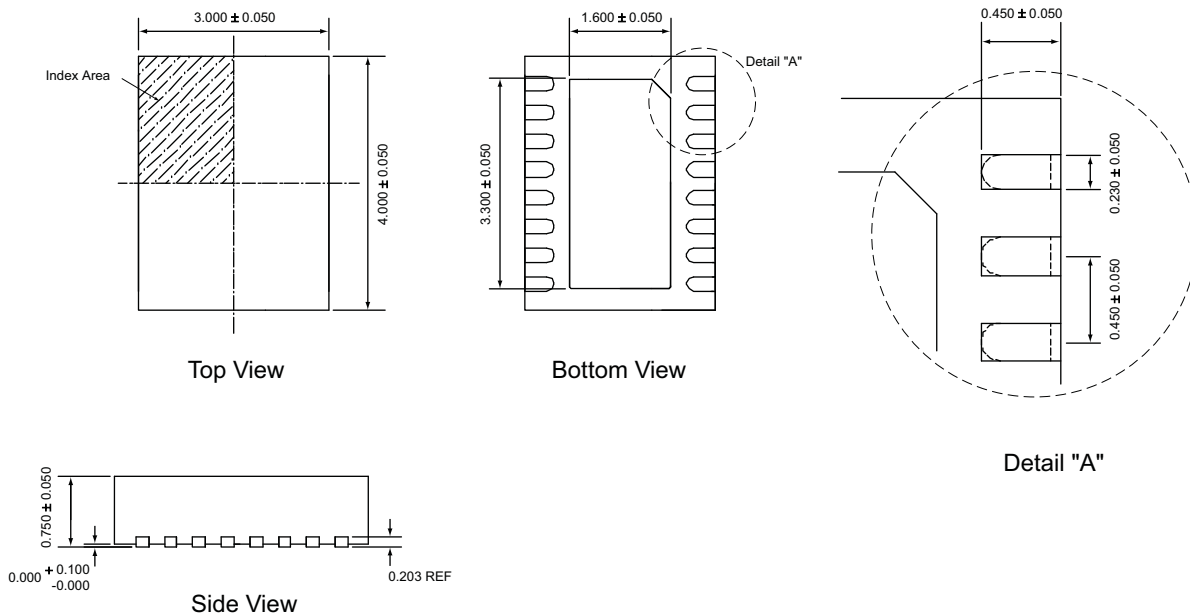

All dimensions in millimeters.

1. XYY = assembly and date code.
2. Sample stock is generally held on part numbers listed in **BOLD**.
3. The leadless package family, which includes QFN, TQFN, DFN, TDFN and STDFN, has exposed copper (unplated) at the end of the lead terminals due to the manufacturing process. A solder fillet at the exposed copper edge cannot be guaranteed and is not required to ensure a proper bottom solder connection.

**Advanced Analogic Technologies, Inc.**  
 3230 Scott Boulevard, Santa Clara, CA 95054  
 Phone (408) 737-4600  
 Fax (408) 737-4611



© Advanced Analogic Technologies, Inc. AnalogicTech cannot assume responsibility for use of any circuitry other than circuitry entirely embodied in an AnalogicTech product. No circuit patent licenses, copyrights, mask work rights, or other intellectual property rights are implied. AnalogicTech reserves the right to make changes to their products or specifications or to discontinue any product or service without notice. Except as provided in AnalogicTech's terms and conditions of sale, AnalogicTech assumes no liability whatsoever, and AnalogicTech disclaims any express or implied warranty relating to the sale and/or use of AnalogicTech products including liability or warranties relating to fitness for a particular purpose, merchantability, or infringement of any patent, copyright or other intellectual property right. In order to minimize risks associated with the customer's applications, adequate design and operating safeguards must be provided by the customer to minimize inherent or procedural hazards. Testing and other quality control techniques are utilized to the extent AnalogicTech deems necessary to support this warranty. Specific testing of all parameters of each device is not necessarily performed. AnalogicTech and the AnalogicTech logo are trademarks of Advanced Analogic Technologies Incorporated. All other brand and product names appearing in this document are registered trademarks or trademarks of their respective holders.